

THE PROPERTY OF THE DRAWING IS ESTABLISHED BY LAW. IT IS FORBIDDEN TO PRODUCE OR SHOW IT TO THIRD PART. WITHOUT A WRITTEN AGREEMENT.

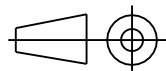
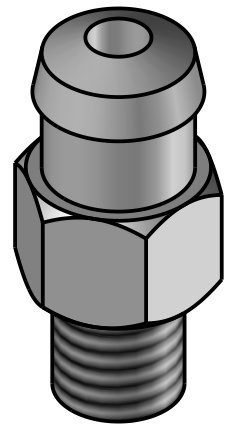
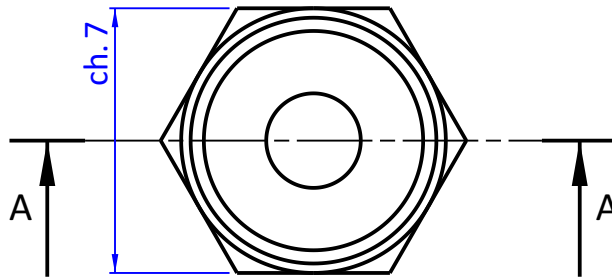
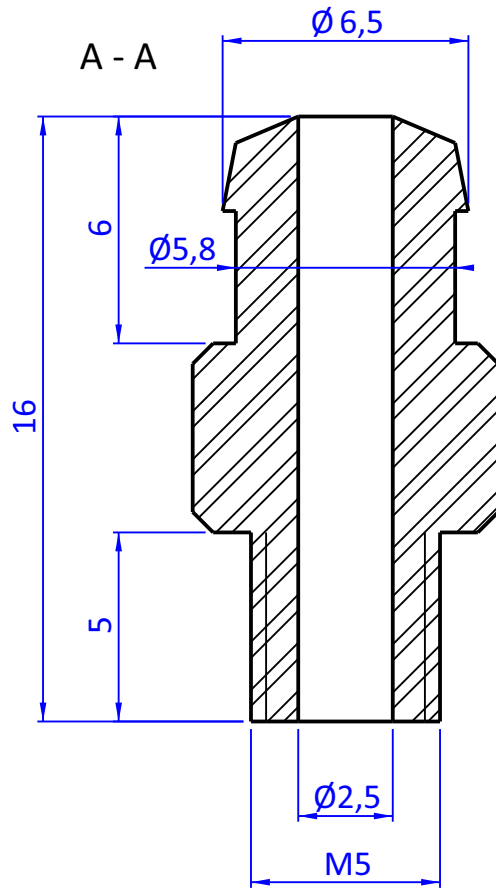

DESIGNED FROM	FPS Automation	REVIEW	A
DATE	02/09/2022	WEIGHT	0,001kg
CODE	CA.08.09.026		

Format	A4
UNI 936-76	

GENERAL TOLERANCE	UNI - ISO 2768
CLASSE	f

DESCRIPTION	CA.08.09.026
-------------	--------------